

# kayak

Office luminaire

Light becomes  
motivation



  
Made in Germany

**REGIOLUX**

# kayak Luminaire family

## Light becomes motivation

Polarised design - the kayak is completely independent, with an individual character. It is more than just a work light. The new floating design is made possible through the light-guide panel technology. It provides an impressive lighting effect which can be uniquely and specifically adjusted for each individual.



# kayak Luminaire family

Control/technology	Mounting	Length	Light colours	Luminous flux	Housing colour
 LC 10	 Suspendant luminaire	1250 mm	 3000K warm white	4600 lm	 white, RAL 9016
 LC 01	 Light run luminaire	1560 mm		4900 lm	 silver, RAL 9006
 DALI	 Surface-mounted luminaire		 4000K neutral white	5900 lm	 black, RAL 9005
 ED				6400 lm	

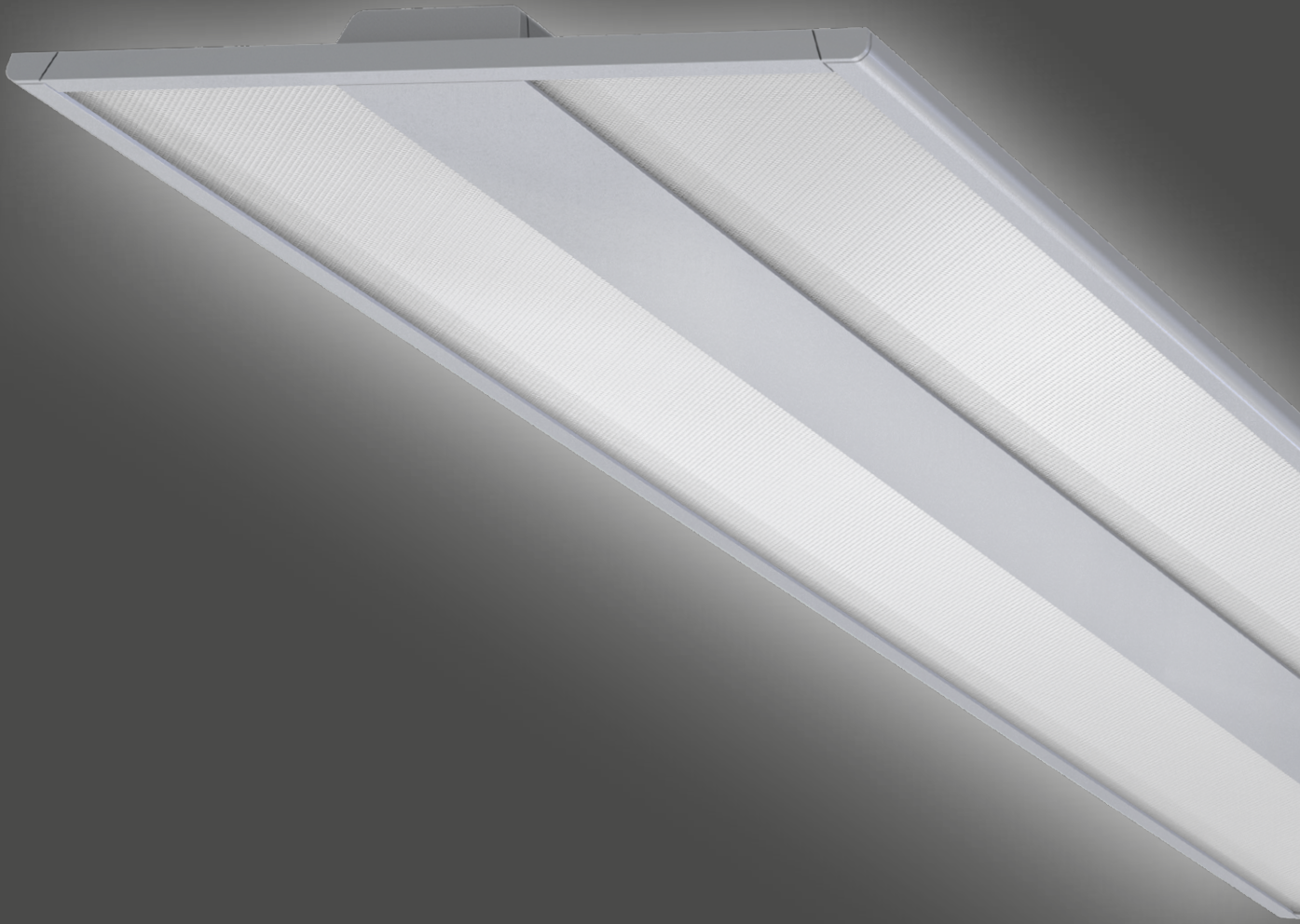

# kayak

In office and workplace lighting, light is more than just illumination. It is a piece towards increased productivity.

Working space is increasingly being treated as living space and so the comfort factor can thus become a decisive company benefit. For this reason we have created extremely functional and yet aesthetically appealing working environments with our kayak luminaire family. To ensure that workers have the best conditions at their workplace.

Light becomes  
motivation

# HIGHLIGHTS



138 lm/W	4600 6400 lm	3000K 4000K	≥80 CRI
DIN EN 12464-1	GR 19	3000	25 75

Made in Germany

white	silver	black
RAL 9016	RAL 9006	RAL 9005

- Wireless . . . . . Wireless lighting controls + sensor luminaire
- Renovation dream . . . . . Dimming even with 3-pole supply line
- Service life . . . . . Peak value 50,000h L90 B10
- Efficiency . . . . . Excellent 138 lm/W
- Perfection . . . . . Homogeneous light at single-screen and dual-screen VDU workstations
- Mounting . . . . . Simple clip system + height adjustable



netlife easy & flex master luminaires,  
the simple, complete solution for lighting control  
Ready for IoT concepts



Ceiling surface mounting made easy  
Using mounting rail with double hooks  
and clip for latching into place

Slim, narrow and discrete - the design canopy in matching housing colour provides space for the wireless controllers of the netlife versions

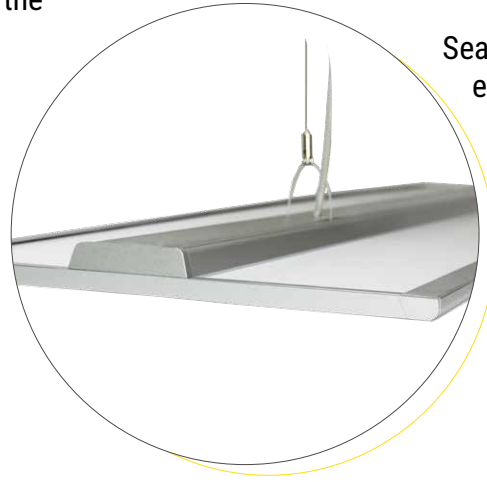

Seamlessly flexible and extremely long:  
Height adjustment from 150 to 1900mm

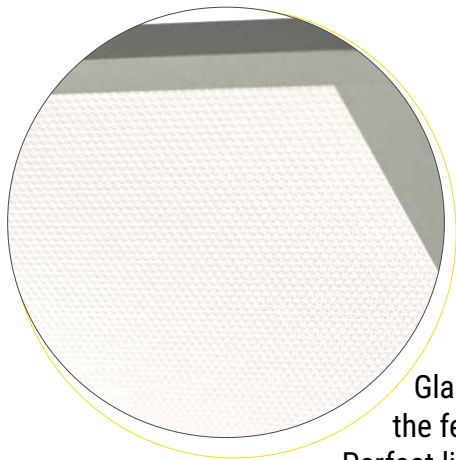

Particularly discrete, flat panel frame made from 10mm thick aluminium



Glare-free light for increasing the feeling of well-being  
Perfect light management  
Latest light-guide precision optics

## Suspended light run

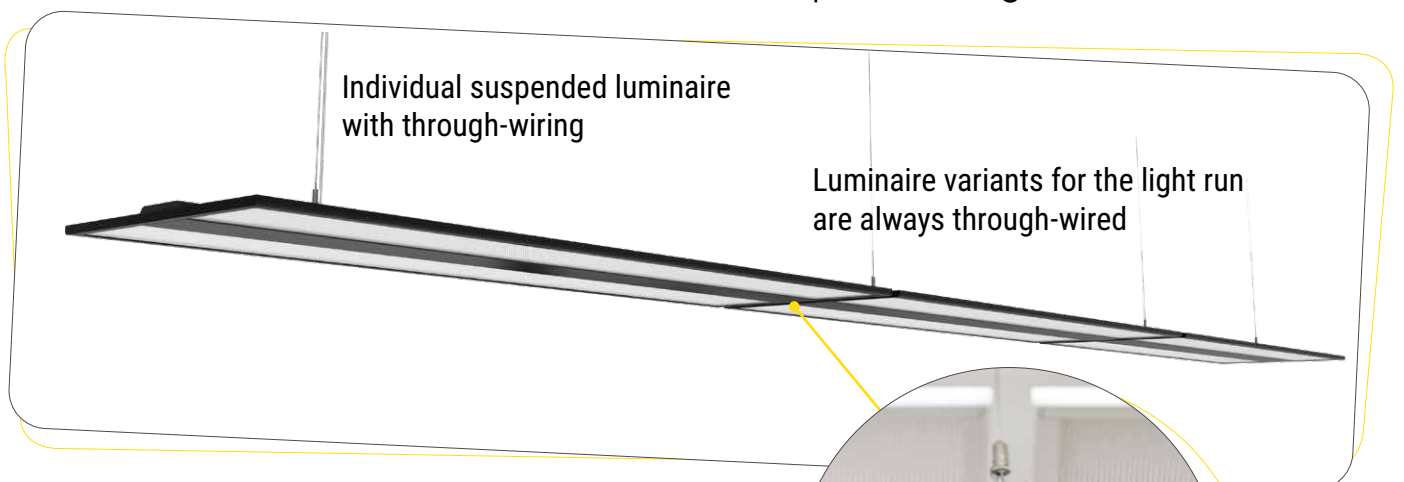

Light connectors for the light run complete-solutions, ready to install with through-wiring



# kayak

## Suspended luminaire

— — —  
**Made in Germany**

9 3000 A++  CE IP 20

### Mounting:

- Suspended

### Housing:

- Frame made of painted extruded aluminium profile, visible installation height 10/24mm

### Lighting technology KYHI:

- Diffuser, micro-prismatic; PMMA plastic
- Lighting characteristic direct/indirect distribution
- Suitable for VDU workstations,  $65^\circ < 3000 \text{ cd/m}^2$ ,  $\text{UGR} \leq 19$  in accordance with DIN-EN 12464-1

### Lamp:

- LED 50000h L90/B10
- CRI  $\geq 80$  / 3000K, 4000K

### Switching:

- Electronic driver, Electronic driver DALI
- 230V 50Hz

### Miscellaneous:

- Luminaires with integrated sensor system and control available
- Complete height-adjustable suspension set included in the scope of delivery

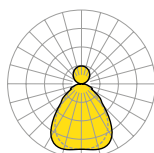
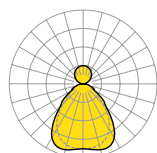

**KYHI/1200 LED**  
4600 lm 830

**KYHI/1500 LED**  
6400 lm 840

$\eta_{LB}$ lm/W	100 % 128	$\eta_{LB}$ lm/W	100 % 135
direct/indirect	74/26 %	direct/indirect	74/26 %
UGR lat./long.	16,3/15,8	UGR lat./long.	17,1/16,4
VDU	$65^\circ < 3000 \text{ cd/m}^2$	VDU	$65^\circ < 3000 \text{ cd/m}^2$



### Dimensions

Type	LxWxH	A1	A2	A3	P min/max
KYHI./1200	1250 x 321 x 24	700			150 - 1900 mm
KYHI./1500	1558 x 321 x 24	900			150 - 1900 mm

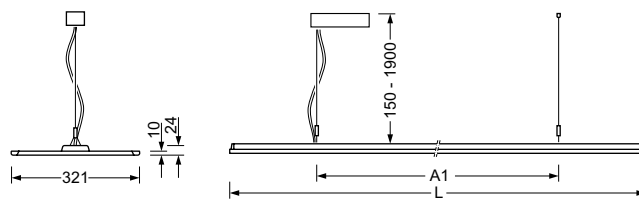

## Our tricolours





## Products

Type	Lamps	lm/W	P <sub>sys</sub> [W]	Colour	Ballast	LxWxH/DxH	Art. no.	kg
<i>Diffuser, micro-prismatic direct/indirect distribution</i>								
kayak-KYHI/1200	LED 4600 830	128	36	vw	ED	1250 x 321 x 24	4620 2024 170	4,90
					DALI <sup>1)</sup>	1250 x 321 x 24	4620 2026 170	4,90
				sw	ED	1250 x 321 x 24	4620 2024 174	4,90
					DALI <sup>1)</sup>	1250 x 321 x 24	4620 2026 174	4,90
				sg	ED	1250 x 321 x 24	4620 2024 175	4,90
					DALI <sup>1)</sup>	1250 x 321 x 24	4620 2026 175	4,90
	LED 4900 840	138	36	vw	ED	1250 x 321 x 24	4620 2014 170	4,90
					DALI <sup>1)</sup>	1250 x 321 x 24	4620 2016 170	4,90
				sw	ED	1250 x 321 x 24	4620 2014 174	4,90
					DALI <sup>1)</sup>	1250 x 321 x 24	4620 2016 174	4,90
				sg	ED	1250 x 321 x 24	4620 2014 175	4,90
					DALI <sup>1)</sup>	1250 x 321 x 24	4620 2016 175	4,90
kayak-KYHI/1500	LED 5900 830	125	48	vw	ED	1558 x 321 x 24	4620 5024 170	6,00
					DALI <sup>1)</sup>	1558 x 321 x 24	4620 5026 170	6,00
				sw	ED	1558 x 321 x 24	4620 5024 174	6,00
					DALI <sup>1)</sup>	1558 x 321 x 24	4620 5026 174	6,00
				sg	ED	1558 x 321 x 24	4620 5024 175	6,00
					DALI <sup>1)</sup>	1558 x 321 x 24	4620 5026 175	6,00
	LED 6400 840	135	48	vw	ED	1558 x 321 x 24	4620 5014 170	6,00
					DALI <sup>1)</sup>	1558 x 321 x 24	4620 5016 170	6,00
				sw	ED	1558 x 321 x 24	4620 5014 174	6,00
					DALI <sup>1)</sup>	1558 x 321 x 24	4620 5016 174	6,00
				sg	ED	1558 x 321 x 24	4620 5014 175	6,00
					DALI <sup>1)</sup>	1558 x 321 x 24	4620 5016 175	6,00

<sup>1)</sup>Luminaires suitable for IoT (Internet of Things): 



## Systematic suspended light run

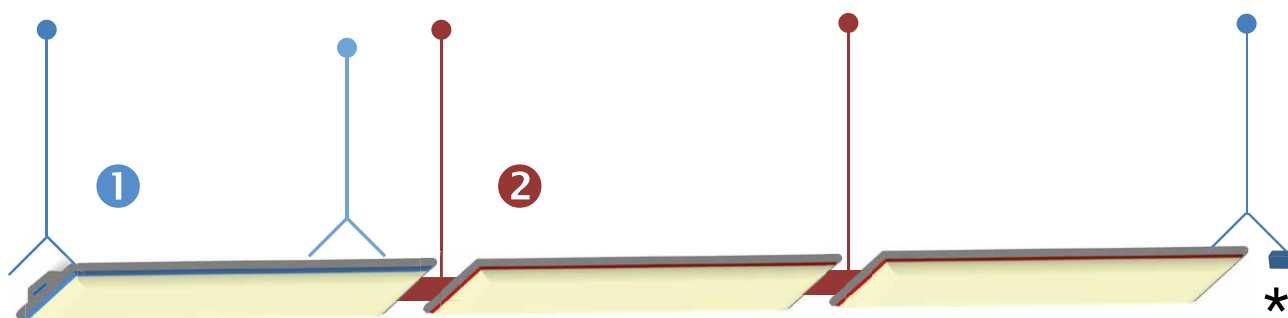

- 1** Individual suspended luminaire generally with through-wiring (incl. complete suspension set)
- 2** Suspended light run luminaire (incl. 1x individual suspension and light run connector)

**\***  
Y-mounting and end face for **1**





# kayak Wireless technologies & Design Thinking

Design Thinking places your desires and requirements at the heart of product developments. We fulfil users' wishes and needs for flexible lighting control with the kayak luminaire family with wireless technologies. As a result, missing wiring is no longer an obstacle in the planning of office work spaces.



Advanced Services design the lighting infrastructure and provide the interfaces for linking in further components. This way we can realise individual lighting concepts, also with Tunable White and Human Centric Lighting, with a great variety of light control components.



In intelligent buildings, lighting systems form the ideal infrastructure for IoT technology. Regiolum provides the required interfaces to IoT systems in luminaires in order to enable them to work together through information and communication technologies. This allows the upgrading and retrofitting of lighting solutions depending on the specific task in question. We mark IoT-capable luminaires with a Ready for IoT symbol.

  
Made in Germany





Sensor detection range

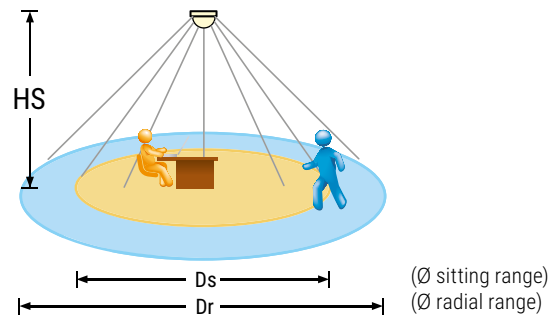

HS	2 m	2.5 m	3 m	3.5 m	5 m
Dr	1.5 - 4.3 m	1.8 - 5.3 m	2 - 6 m	2.5 - 7 m	7 m
Ds	1.5 - 2.5 m	1.8 - 3.3 m	2 - 6 m	2.5 - 5 m	

### Wireless external Bluetooth technology enables simple dimming and control

Presence control with and without daylight control is possible via the easy 01-Controller installed in the canopy

Via free Osram apps:

OSRAM BT CONFIG for configuring  
OSRAM BT CONTROL for control

Presence control / daylight control as well as basic functions such as set-point value, delay time and other advanced functions can be conveniently set for up to 32 luminaires

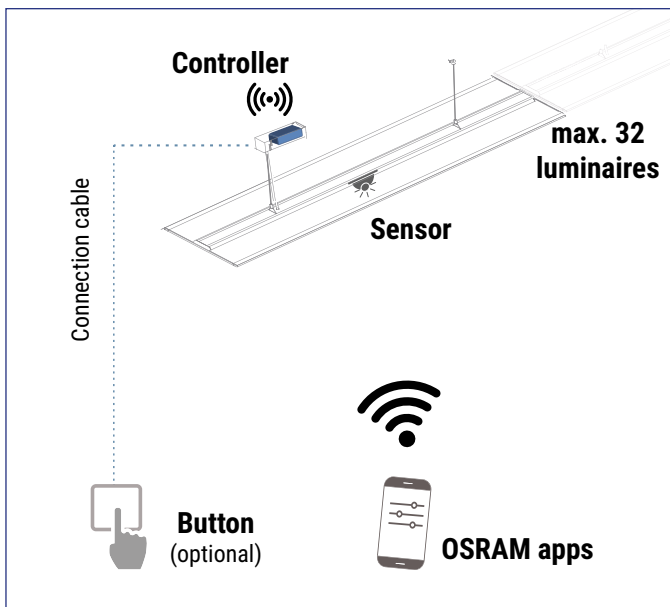

OSRAM BT CONFIG

OSRAM BT CONTROL



### Accessories:

Optionally, a push-button can be connected to the master luminaire to start the semi-automatic control or for manual operation.

### Products

Type	Lamps	lm/W	P <sub>sys</sub> [W]	Colour	Ballast	LxWxH/DxH	Art. no.	kg
<i>Diffuser, micro-prismatic direct/indirect distribution</i>								
kayak-KYHI/1500	LED 5900 830	125	48	vw	DALI easy01	1558 x 321 x 24	4620 5526 170	6,30
				sw	DALI easy01	1558 x 321 x 24	4620 5526 174	6,30
				sg	DALI easy01	1558 x 321 x 24	4620 5526 175	6,30
	LED 6400 840	135	48	vw	DALI easy01	1558 x 321 x 24	4620 5516 170	6,30
				sw	DALI easy01	1558 x 321 x 24	4620 5516 174	6,30
				sg	DALI easy01	1558 x 321 x 24	4620 5516 175	6,30

Wireless control and set-up via free app



**Wireless external Bluetooth technology enables simple dimming and control**

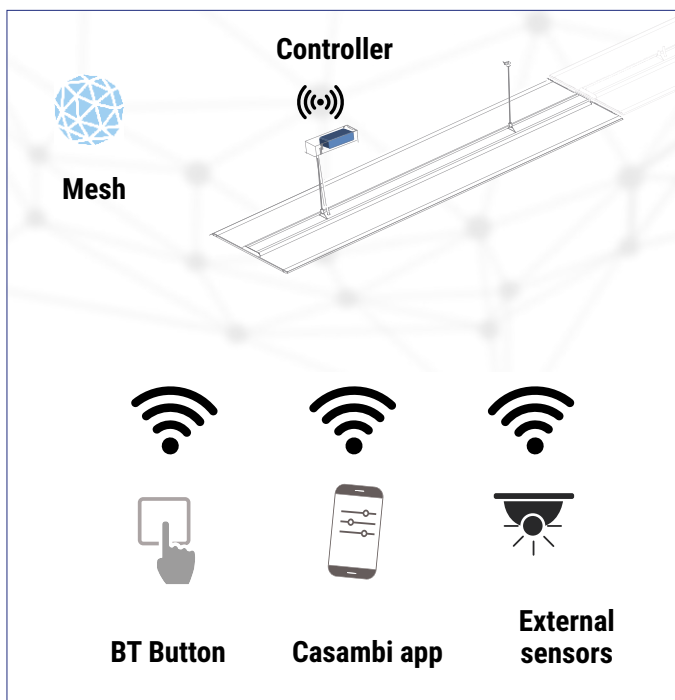

### flex 10 controller

With the Casambi-compliant controller, the kayak flex 10 becomes an intelligent IoT solution. The Bluetooth controller is ideally positioned, out of sight, in the canopy.

**Can be wirelessly configured via Bluetooth:**

- Daylight control, corridor function, movement detection
- External sensors for individual DALI luminaires via the Casambi app
- Bluetooth mesh links additional flex 10 luminaires

In conjunction with external sensors, the luminaire can be individually configured and controlled via the Casambi app, with all typical functions such as daylight control, corridor function, presence control, Tunable White and Human Centric Lighting. With further flex 10 luminaires being linked in via Bluetooth mesh.

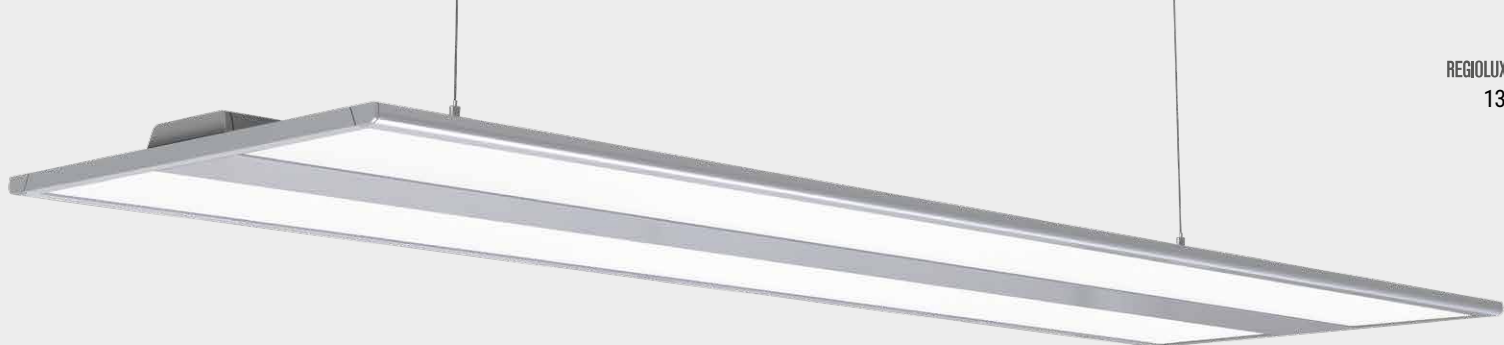

**Casambi app**  
**The free command centre**

It provides an independent overview of the networks available and support during configuration



**Bluetooth button: wireless switching via Bluetooth**

Maximum flexibility with this wireless control unit, without cabling and free of batteries!

Bluetooth wall button

LC-RX FLEX BT PB 4W, art. no: 8450 8108 100

LC-RX FLEX BT PB 2W, art. no: 8450 8107 100

**For system expansion:**

External Bluetooth sensors with Casambi-compatible sensor system

LC-RX FLEX BT Sensor Office SR, art. no: 8450 8110 100 (ceiling surface mounting)

LC-RX FLEX BT Sensor Office FM, art. no: 8450 8111 100 (recessed ceiling installation)

**Products**

Type	Lamps	lm/W	P <sub>sys</sub> [W]	Colour	Ballast	LxWxH/DxH	Art. no.	
<i>Diffuser, micro-prismatic direct/indirect distribution</i>								
kayak-KYHI/1500	LED 5900 830	125	48	vw	DALI flex10	1558 x 321 x 24	4620 5626 170	6,20
				sw	DALI flex10	1558 x 321 x 24	4620 5626 174	6,20
				sg	DALI flex10	1558 x 321 x 24	4620 5626 175	6,20
	LED 6400 840	135	48	vw	DALI flex10	1558 x 321 x 24	4620 5616 170	6,20
				sw	DALI flex10	1558 x 321 x 24	4620 5616 174	6,20
				sg	DALI flex10	1558 x 321 x 24	4620 5616 175	6,20



**Mounting:**

- Ceiling surface

**Housing:**

- Frame made of painted extruded aluminium profile, visible installation height 10/24mm

**Lighting technology KYAI:**

- Bottom diffuser micro-prismatic / top diffuser clear; PMMA plastic
- Lighting characteristic direct distribution / indirect distribution for ceiling lighting
- Suitable for VDU workstations,  $65^\circ < 3000 \text{ cd/m}^2$ ,  $\text{UGR} \leq 19$  in accordance with DIN-EN 12464-1

**Lamp:**

- LED 50000h L90/B10
- CRI  $\geq 80$  / 3000K, 4000K

**Switching:**

- Electronic driver, Electronic driver DALI
- 230V 50Hz

**Miscellaneous:**

- Ceiling attachment rails required for mounting are included in the scope of delivery

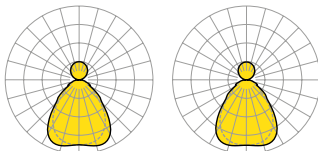

KYAI/1200 LED 4600 lm 830		KYAI/1500 LED 6400 lm 840	
$\eta_{LB}$	100 %	$\eta_{LB}$	100 %
lm/W	128	lm/W	135
direct/indirect	74/26 %	direct/indirect	74/26 %
UGR lat./long.	16.3/15.8	UGR lat./long.	17.1/16.4
VDU	$65^\circ < 3000 \text{ cd/m}^2$	VDU	$65^\circ < 3000 \text{ cd/m}^2$



**Dimensions**

Type	LxWxH/DxH	A1	KE X/Y
KYAI/1200	1250 x 321 x 39	900	0 / 0
KYAI/1500	1558 x 321 x 39	900	0 / 0

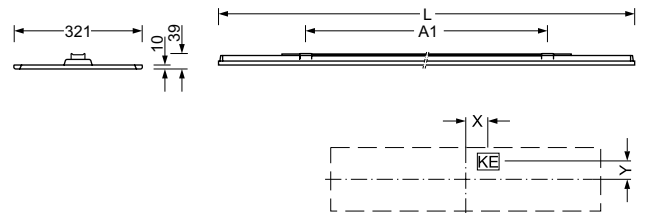

**Connection made simple**

In the case of surface-mount luminaires, the mounting rail is fitted first. Then both hands are free to connect the luminaire thanks to suspension from the double-hooks. Finally, the connection piece is simply latched into place with a click and then secured.

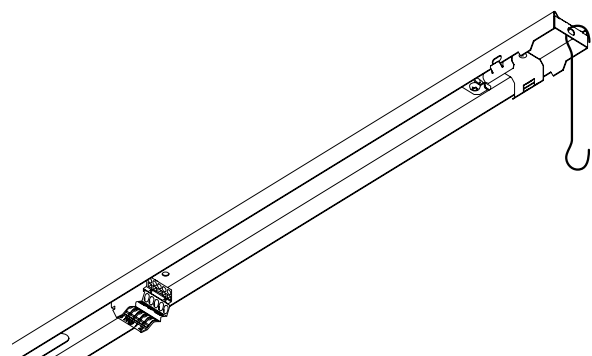



Products

Type	Lamps	lm/W	P <sub>sys</sub> [W]	Colour	Ballast	LxWxH/DxH	Art. no.	
<i>Bottom diffuser micro-prismatic / top diffuser clear direct distribution / indirect distribution for ceiling lighting</i>								
kayak-KYAI/1200	LED 4600 830	128	36	vw	ED	1250 x 321 x 39	4630 2024 170	4,75
					DALI <sup>1)</sup>	1250 x 321 x 39	4630 2026 170	4,75
					sw	ED	1250 x 321 x 39	4630 2024 174
				DALI <sup>1)</sup>	1250 x 321 x 39	4630 2026 174	4,75	
				sg	ED	1250 x 321 x 39	4630 2024 175	4,75
				DALI <sup>1)</sup>	1250 x 321 x 39	4630 2026 175	4,75	
	LED 4900 840	138	36	vw	ED	1250 x 321 x 39	4630 2014 170	4,75
					DALI <sup>1)</sup>	1250 x 321 x 39	4630 2016 170	4,75
					sw	ED	1250 x 321 x 39	4630 2014 174
				DALI <sup>1)</sup>	1250 x 321 x 39	4630 2016 174	4,75	
				sg	ED	1250 x 321 x 39	4630 2014 175	4,75
				DALI <sup>1)</sup>	1250 x 321 x 39	4630 2016 175	4,75	
kayak-KYAI/1500	LED 5900 830	125	48	vw	ED	1558 x 321 x 39	4630 5024 170	5,94
					DALI <sup>1)</sup>	1558 x 321 x 39	4630 5026 170	5,94
					sw	ED	1558 x 321 x 39	4630 5024 174
				DALI <sup>1)</sup>	1558 x 321 x 39	4630 5026 174	5,94	
				sg	ED	1558 x 321 x 39	4630 5024 175	5,94
				DALI <sup>1)</sup>	1558 x 321 x 39	4630 5026 175	5,94	
	LED 6400 840	135	48	vw	ED	1558 x 321 x 39	4630 5014 170	5,94
					DALI <sup>1)</sup>	1558 x 321 x 39	4630 5016 170	5,94
					sw	ED	1558 x 321 x 39	4630 5014 174
				DALI <sup>1)</sup>	1558 x 321 x 39	4630 5016 174	5,94	
				sg	ED	1558 x 321 x 39	4630 5014 175	5,94
				DALI <sup>1)</sup>	1558 x 321 x 39	4630 5016 175	5,94	

<sup>1)</sup>Luminaires suitable for IoT (Internet of Things): 

” LIGHT & MOTIVATION  
THE KAYAK BRINGS THEM  
INTO YOUR OFFICE ”



9999\_1631\_219\_1A\_100003/19\_MA/Digi\_ Änderungen vorbehalten

## Photo index

### Page

- 1 arthead · 123rf.com
- 2 phive2015 · 123rf.com
- 7 pisaphotography · shutterstock.com
- 8 ImageFlow · shutterstock.com
- 10 denisismagilov · adobe.stock.com
- 16 filadendron · istock.com

9999\_1691\_218\_1A\_1500\_12/19\_MA/SCH\_ Subject to change



REGIOLUX @ SOCIAL MEDIA



Regiolux VCard



**REGIOLUX**  
Regiolux GmbH  
Hellinger Straße 3  
D 97486 Königsberg  
T +49 9525 89 0  
info@regiolux.de  
www.regiolux.de