

HC038V/BT HCD038/BT
0/1-10V Output DALI Output

Produktbeschreibung

Der HC038V/BT ist ein 0/1-10V Steuergerät, HCD038/BT ist dagegen ein DALI-Steuergeräte der mit einer eingebauten 30mA DALI-Stromversorgung steuerbar ist. Diese Produkte können mit einer großen Produktpalette von HF- und PIR-Sensorköpfen zusammenarbeiten. Da das Bluetooth-Modul im inneren des Steuergerätes eingebaut ist, eignen Sie sich ideal für Kunststoffleuchten, aber auch für Innenanwendungen wie Büros, Klassenzimmer, Parkhäuser, Lagerhallen. Mit dem drahtlosen Bluetooth-Mesh-Netzwerk wird die Kommunikation ohne Festverdrahtung viel einfacher und verleiht der Leuchte einen Mehrwert. Sie können Ihre Geräte ganz einfach über die **Koolmesh™** App einrichten und in betrieb nehmen.



App Funktionen

Leuchtengruppen über Meshnetz

- Raum & Gruppe
- Synchronisationssteuerung

7 Szenenoptionen:

- Allgemeine Szene
- Lux ON/OFF Szene
- Daylight Harvest (offener Kreislauf)
- Daylight Harvest (geschlossener Kreislauf)
- Einfacher zirkadianer Rhythmus ohne Tageslichtsensor (HCD038/BT)
- Fortgeschrittener zirkadianer Rhythmus mit Tageslichtsensor (HCD038/BT)
- Zeitbasierte Szene

Taster Konfiguration

Detaillierte Bewegungssensor Einstellungen

Zeitgesteuerte Szenen

Astro timer

Grundrissfunktion für Projektplanung

Treppenhausfunktion (Master und Slave)

Geräteeinstellung im offline-Modus

Verwaltung von unterschiedlichen Berechtigungen

Gemeinsame Nutzung des Netzwerks über QR-Code oder Keycode

Fernsteuerung über Gateway-Unterstützung HBGW01

Kompatibilität mit dem Bluetooth-Produktportfolio von Hytronik

Kompatibel mit den Funkschaltern von EnOcean

Geräte-Firmware-Aktualisierung over-the-air (OTA)

Hardware-Eigenschaften

HC038V/BT: 0/1-10V Ausgang :

- 400VA (kapazitive)
- 800W (ohmsche)

HCD038/BT: 30mA DALI broadcast Ausgang für bis zu 15 LED Treiber

Plug'n'Play für flexible Installation und kostensparende Montage Unterstützung zur Steuerung von DT8-LED-Treiber (HCD038/BT)

Unterstützung zur Steuerung von DT8-LED-Treibern

2 Taster-Eingänge für flexible manuelle Steuerung (HCD038/BT)

Nulldurchgangsschaltung zur Reduzierung des Einschaltstroms und zur Verlängerung der Lebensdauer des Relais (HC038V/BT)

Loop-in and loop-out für eine einfache Installation (HC038V/BT)

5 Jahre Garantie

Bluetooth 5.0 SIG mesh

ab iOS 10.0

ab Android 5.0





Web app/platform:
iot.koolmesh.com



EnOcean
Self-powered IoT

Fully support
EnOcean switch
EWSSB/EWSDB

Technische Daten (HC038V/BT & HCD038/BT)

Bluetooth-/Empfänger	
Betriebsfrequenz	2.4 GHz - 2.483 GHz
Übertragungsleistung	7 dBm
Reichweite (Innenraum)	10~30m
Version	Bluetooth® 5.0 SIG Mesh
Sicherheit und EMC Normen	
EMC Normen	EN55015, EN61000, EN61547
Sicherheitsnormen (LVD)	EN60669-1, EN60669-2-1
Radio Equipment (RED)	EN300328, EN301489-1/-17
Zertifizierung	Semko, CB, CE, EMC, RED, RCM

Input & Output Merkmale	
Netzspannung	220~240VAC 50/60Hz
Stand-by	<1W
Schaltleistung	
HC038V/BT	kapazitive: 400W; ohmsche: 800W
HCD038/BT	30mA (max. 15 Geräte)
Startzeit	20s
Betriebsdaten	
Umgebungstemperatur	Ta: -20°C ~ +55°C
Gehäusetemperatur (Max.)	Tc: +75°C
IP Schutzart	IP20

Mechanischer Aufbau & Abmessungen

HC038V/BT (0/1-10V Ausgang)

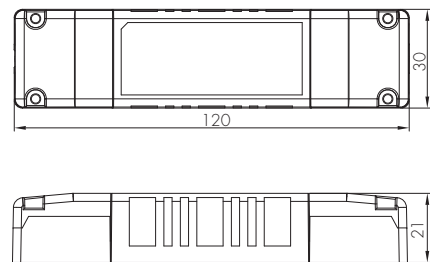
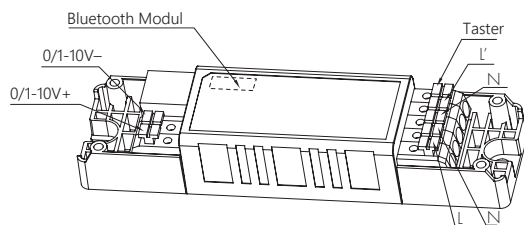

HCD038/BT (DALI Ausgang)

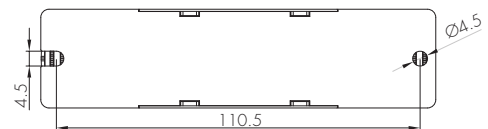
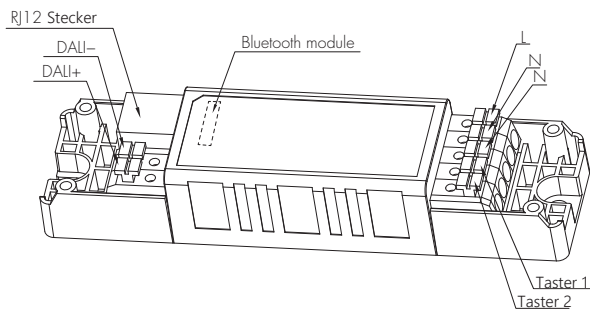

Vorbereitung der Kabel

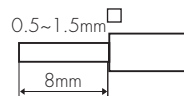

Zum Befestigen oder Lösen des Kabels von der Klemme: drücken Sie den Knopf mit einem Schraubendreher nach unten

Schaltplan

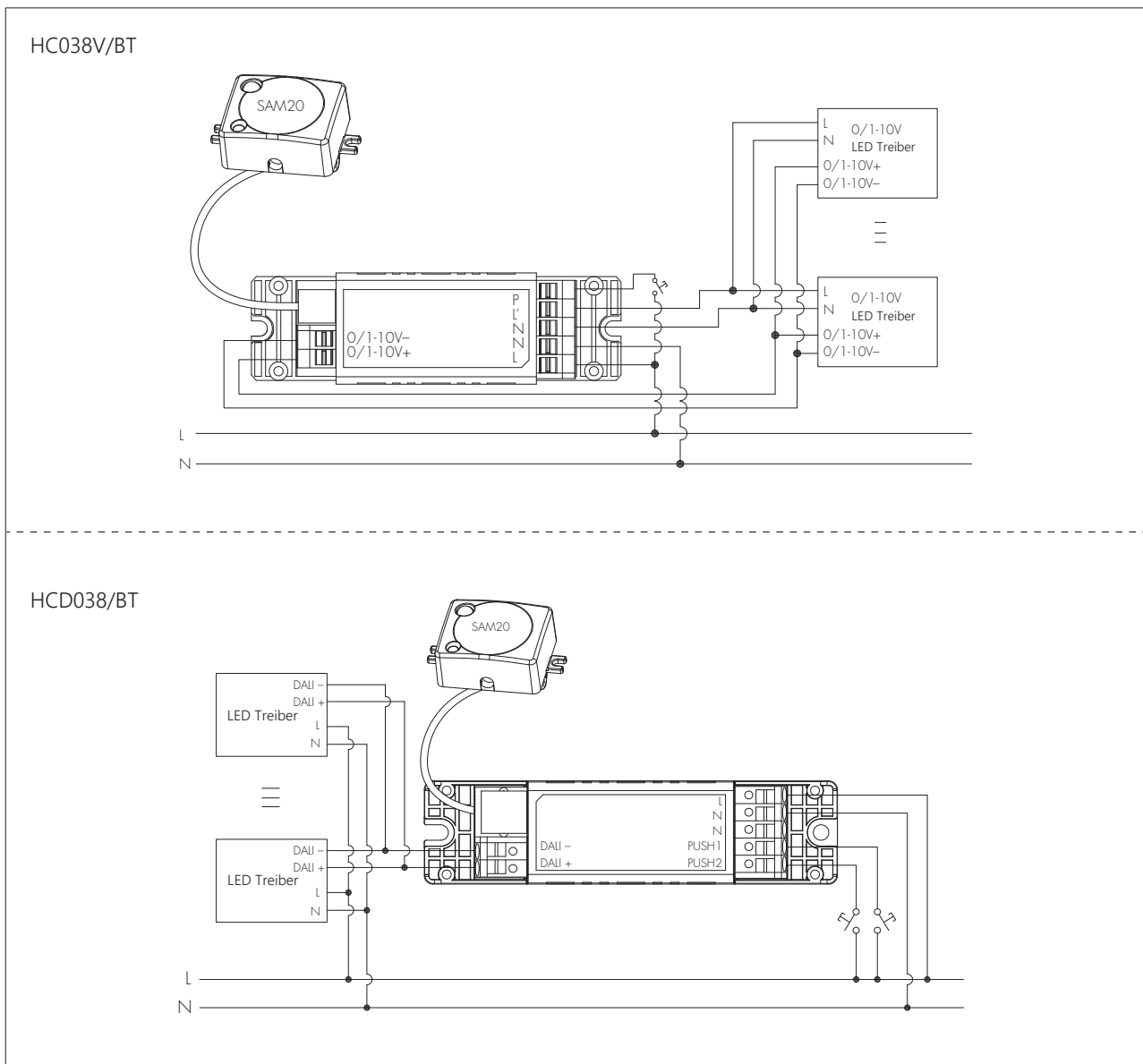

Technische Daten für Sensorköpfe

PIR-Sensor-Eigenschaften		HF Sensor Eigenschaften	
Sensor Art	PIR Erfassung	Sensor Art	HF Erfassung
Betriebsspannung	5VDC	Betriebsspannung	5VDC
Erfassungsbereich*	HIR05/HIR07 Max Installationshöhe: 3m Max Erfassungsbereich: 6m (Ø Durchmesser)	Betriebsfrequenz	5.8GHz +/- 75MHz
	HIR11 Max Installationshöhe: 15m (Gabelstapler) 12m (Person) Max Erfassungsbereiche: 20m (Ø Durchmesser)	Übertragungsleistung	<0.2mW
	HIR12 Max Installationshöhe: 15m (Gabelstapler) 12m (Person) Max Erfassungsbereich: 18m * 6m (L * B)	Erfassungsbereich*	SAM20 / SAM21 / SAM22 Max Installationshöhe: 3m Max Erfassungsbereich: 12m (Ø Durchmesser)
			SAM23 Max Installationshöhe: 15m (Gabelstapler) 12m (Person) Max Erfassungsbereich: 20m (Ø Durchmesser)

* Der Erfassungsbereich wird durch die Sensorplatzierung (Winkel) und unterschiedliche Gehgeschwindigkeiten beeinflusst.

PIR- und HF Sensorköpfe

Die unten aufgeführten PIR- und HF Sensorköpfe bieten eine Vielzahl von Plug'n'Play-Optionen, die die Flexibilität des Leuchtendesigns erweitern.

A. HIR05

PIR Sensor Kopf
Die Kabellänge beträgt ca 65cm.



B. HIR07

PIR Sensor Kopf
Photocell Advance™
Die Kabellänge beträgt ca 30cm.



C. HIR11/S

PIR Sensor Kopf
Oberflächenmontage Highbay
IP42 (IP64 kann auf Anfrage erstellt werden)
Die Kabellänge beträgt ca 65cm.



D. HIR11/F

PIR Sensor Kopf
Unterputzmontage
Highbay
IP42 (IP64 kann auf Anfrage erstellt werden)
Die Kabellänge beträgt ca 65cm.



E. HIR11/C

PIR Sensor Kopf
Seitliche Montage an der Leuchte
Highbay
IP42 (IP64 kann auf Anfrage erstellt werden)
Die Kabellänge beträgt ca 65cm.



F. HIR12

PIR Sensor Kopf
Highbay
IP65
Die Kabellänge beträgt ca 65cm.



Installation für HIR12



Wir empfehlen eine Blechstärke von 0,8 mm - 1,6 mm, um eine perfekte Fokussierung für die PIR-Linse zu gewährleisten.

H. SAM20

HF Sensor Kopf
Photocell Advance™
Die Kabellänge beträgt ca 30cm.



I. SAM21

HF Sensor Kopf
Photocell Advance™
IP65
Die Kabellänge beträgt ca 65cm.



J. SAM22

HF Sensor Kopf
Unterputzmontage
Die Kabellänge beträgt ca 65cm.



K. SAM23

HF Sensor Kopf
Photocell Advance™
Tageslichtsensor
Highbay
Die Kabellänge beträgt ca 30cm.



Optionales Zubehör: abgesetzte Bluetooth-Antenne

Dank der verstärkten Bluetooth-Antenne, die der Steuergerät HC038V/BT & HCD038/BT hinzugefügt wird, vergrößert sich die Reichweite (Smart-gerät zu Steuergerät) auf 20 m, die Distanz von Gerät zu Gerät beträgt etwa 50 m.



Erfassungsbereich

SAM23



Erfassungsbereich bei Deckenmontage (m)

SAM20 / SAM21 / SAM22



Erfassungsbereich bei Deckenmontage (m)

HIRO5 / HIRO7



HIR11



HIR12



Hinweise zum bedienen der Taster

Switch-Dim

Die bereitgestellte Switch-Dim-Schnittstelle ermöglicht eine einfache Dimmmethode unter Verwendung handelsüblicher nicht einrastender (Taster) Wandschalter. Detaillierte Push-Schalter-Konfigurationen können in der Koolmesh-App eingestellt werden.

Schalter-Funktion	Maßnahme	Erläuterungen
Push switch	Kurz drücken (<1 Sekunde)	- Ein-/Ausschalten - Nur einschalten - Nur ausschalten - Szene zurückrufen - Beenden des manuellen Modus - Keine weiteren Änderungen
	Doppelt Drücken	- Nur einschalten - Nur ausschalten - Szene zurück rufen - Beenden des manuellen Modus - Keine weiteren Änderungen
	Lange Drücken (≥1 Sekunde)	- Dimmen - Farbabstimmung - Keine weiteren Änderungen
Sensor simulieren	/	- Upgrade eines normalen Ein/Aus-Bewegungssensors zu einem Bluetooth-gesteuerten Bewegungssensor

Zusätzliche Informationen / Dokumente

1. Für eine vollständige Erklärung der Hytronik Photocell Advance™
[www.hytronik.com/download ->knowledge ->Introduction of Photocell Advance](http://www.hytronik.com/download->knowledge->Introduction%20of%20Photocell%20Advance)
2. Detaillierten Produkteigenschaften/Funktionen
[www.hytronik.com/download ->knowledge ->Introduction of App Scenes and Product Functions](http://www.hytronik.com/download->knowledge->Introduction%20of%20App%20Scenes%20and%20Product%20Functions)
3. Vorsichtsmaßnahmen für die Installation und den Betrieb von Bluetooth-Produkten
[www.hytronik.com/download ->knowledge ->Bluetooth Products - Precautions for Product Installation and Operation](http://www.hytronik.com/download->knowledge->Bluetooth%20Products%20-%20Precautions%20for%20Product%20Installation%20and%20Operation)
4. Vorsichtsmaßnahmen für die Installation und den Betrieb von HF Sensoren
[www.hytronik.com/download ->knowledge ->Microwave Sensors - Precautions for Product Installation and Operation](http://www.hytronik.com/download->knowledge->Microwave%20Sensors%20-%20Precautions%20for%20Product%20Installation%20and%20Operation)
5. Vorsichtsmaßnahmen für die Installation und den Betrieb von PIR Sensoren
[www.hytronik.com/download ->knowledge ->PIR Sensors - Precautions for Product Installation and Operation](http://www.hytronik.com/download->knowledge->PIR%20Sensors%20-%20Precautions%20for%20Product%20Installation%20and%20Operation)
6. Das Datenblatt kann ohne Vorankündigung geändert werden. Bitte beziehen Sie sich immer auf die aktuellste Version
[www.hytronik.com/products/bluetooth technology ->Bluetooth Sensors](http://www.hytronik.com/products/bluetooth%20technology->Bluetooth%20Sensors)
7. Hytronik-Standardgarantie
[www.hytronik.com/download ->knowledge ->Hytronik Standard Guarantee Policy](http://www.hytronik.com/download->knowledge->Hytronik%20Standard%20Guarantee%20Policy)

HYTRONIK ELECTRONICS CO.,LTD
3rd Floor, block C, complex building, 155#, Bai'gang road south, Bai'gang village
Xiao Jin Kou town, Huicheng district
516023 Huizhou
China

Detached Motion Sensor with  Bluetooth® 5.0 SIG Mesh

HC038V/BT

0/1-10V Output

HCD038/BT

DALI Output

HYTRONIK®



Product Description

HC038V/BT is a Bluetooth 0/1-10V control base whereas HCD038/BT is a Bluetooth DALI control base with 30mA DALI power supply built in. They work with a wide range of microwave and PIR sensor heads. They are ideal for plastic luminaires as compared to metal luminaires because Bluetooth signal can transmit through plastic. They are suitable for any typical indoor applications such as office, classroom, car park, warehouse and other commercial/industrial areas. With Bluetooth wireless mesh networking, it makes communication much easier without any hardwiring, which eventually adds values to luminaires and saves costs for projects. Meanwhile, simple device setup and commissioning can be done via **Koolmesh™** app.



HC038V/BT











HCD038/BT

App Features

-  Grouping luminaires via mesh network
 - Two levels: room & group
 - Synchronization control
-  7 types of scene options to set up:
 - Generic Scenes
 - Lux ON/OFF Scenes
 - Daylight Harvest (Open loop)
 - Daylight Harvest (Closed loop)
 - Simple circadian rhythm without daylight sensor (HCD038/BT)
 - Advanced circadian rhythm with daylight sensor (HCD038/BT)
 - Time-based Scene
-  Push switch configuration
-  Detailed motion sensor settings
-  Schedule to run scenes based on time and date
-  Astro timer (sunrise and sunset)
-  Floorplan feature to simplify project planning
-  Staircase function (master & slave)
-  Offline commissioning
-  Different permission levels via authority management
-  Network sharing via QR code or keycode
-  Remote control via gateway support HBGW01
-  Interoperability with Hytronik Bluetooth product portfolio
-  Compatible with EnOcean range of wireless switches
-  Device firmware update over-the-air (OTA)
-  Continuous development in progress...

Hardware Features

-  HC038V/BT: 0/1-10V output :
 - 400VA (capacitive)
 - 800W (resistive)
-  HCD038/BT: 30mA DALI broadcast output for up to 15 LED drivers
-  Plug'n'Play for flexible installation and cost saving assemble
-  Support to control DT8 LED drivers (HCD038/BT)
-  2 Push inputs for flexible manual control(HCD038/BT)
-  Zero crossing detection circuit to reduce in-rush current and prolong relay lifetime (HC038V/BT)
-  Loop-in and loop-out terminals for efficient installation (HC038V/BT only)
-  5-year warranty

 **Bluetooth 5.0 SIG mesh**



iOS 10.0 or later





Android 5.0 or later





Web app/platform:
iot.koolmesh.com



EnOcean
Self-powered IoT

Fully support
EnOcean switch
EWSSB/EWSDB

Technical Specifications (HC038V/BT HCD038/BT)

Bluetooth Transceiver	
Operation frequency	2.4 GHz - 2.483 GHz
Transmission power	7 dBm
Range (Typical indoor)	10~30m
Protocol	Bluetooth® 5.0 SIG Mesh
Safety & EMC	
EMC standard (EMC)	EN55015, EN61000, EN61547
Safety standard (LVD)	EN60669-1, EN60669-2-1
RED	EN300328, EN301489-1/-17
Certification	Semko, CB, CE, EMC, RED, RCM

Input & Output Characteristics	
Operating voltage	220~240VAC 50/60Hz
Stand-by power	<1W
Load ratings: HC038V/BT HCD038/BT	Capacitive: 400W; Resistive: 800W 30mA (max. 15 devices)
Warming-up	20s
Environment	
Operation temperature	Ta: -20°C ~ +55°C
Case temperature (Max.)	Tc: +75°C
IP rating	IP20

Mechanical Structure & Dimensions

HC038V/BT (0/1-10V output)



HCD038/BT (DALI output)



Wire Preparation

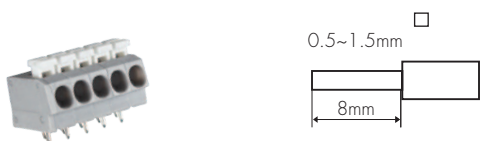

To make or release the wire from the terminal, use a screwdriver to push down the button.

Wiring Diagram



Technical Specifications for Sensor Heads

PIR Sensor Properties	
Sensor principle	PIR detection
Operating voltage	5VDC
Detection range *	HIRO5 / HIRO7 Max installation height: 3m Max detection range: 6m (diameter)
	HIR11 Max installation height: 12m Max detection range: 16m (diameter)
	HIR12 Max installation height: 15m Max detection range: 18m (length) Max detection range: 6m (width)

HF Sensor Properties	
Sensor principle	High Frequency (microwave)
Operating voltage	5VDC
Operation frequency	5.8GHz +/- 75MHz
Transmission power	<0.2mW
Detection range *	SAM20 / SAM21 / SAM22 Max installation height: 3m Max detection range: 12m (diameter)
	SAM23 Max installation height: 12m Max detection range: 16m (diameter)

* The detection range is heavily influenced by sensor placement (angle) and different walking paces. It may be reduced under certain conditions.

PIR & microwave sensor heads

The range of PIR and microwave sensor heads below offers powerful number of Plug'n'Play feature options to expand the flexibility of luminaire design. This approach to luminaire design reduces space requirements and component costs whilst simplifying production.

A. HIR05

PIR sensor head
The cable length is around 65cm.

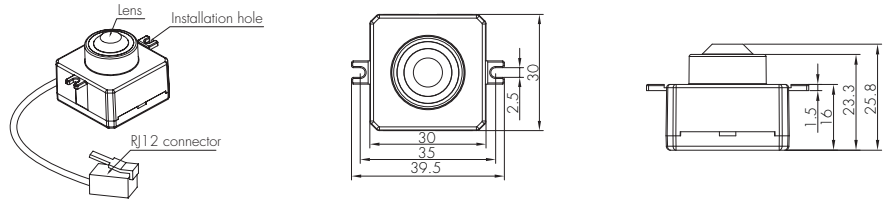

B. HIR07

PIR sensor head
Photocell Advance™
The cable length is around 30cm.



C. HIR11/S

PIR sensor head
Surface mounting
For highbay application
Lens part IP42 (IP64 can be made upon request)
The cable length is around 65cm.

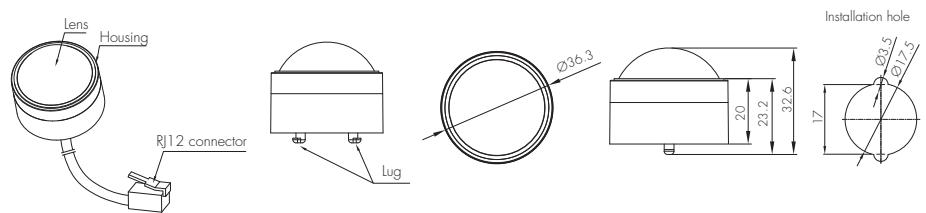

D. HIR11/F

PIR sensor head
Flush mounting
For highbay application
Lens part IP42 (IP64 can be made upon request)
The cable length is around 65cm.

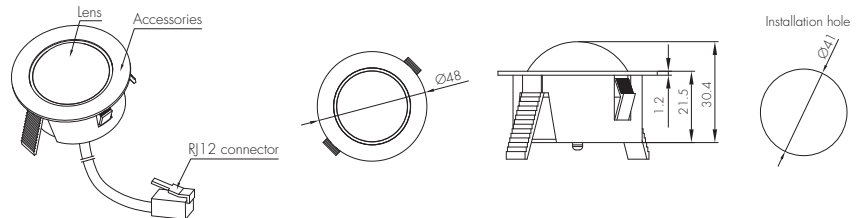

E. HIR11/C

PIR sensor head
Screw to the luminaire by conduit
For highbay application
Lens part IP42 (IP64 can be made upon request)
The cable length is around 65cm.

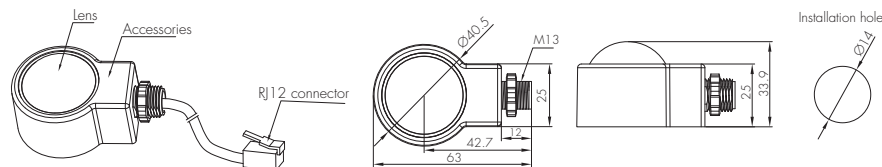

F. HIR12

PIR sensor head
For highbay application
IP65(lens part)
The cable length is around 65cm.

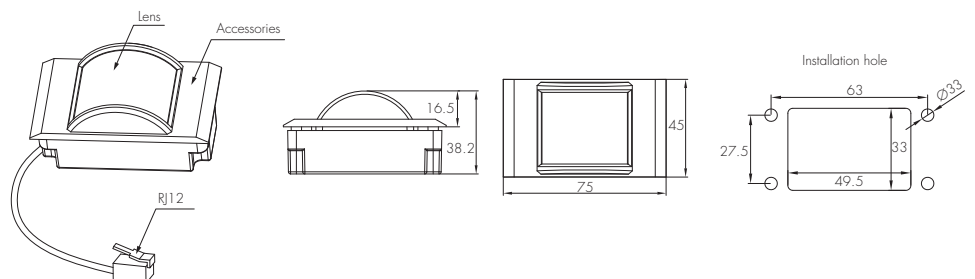

Installation for HIR12



We suggest that the metal plate thickness to be 0.8mm - 1.6mm to ensure perfect focal length for the PIR lens.

H. SAM20

HF sensor head
 Photocell Advance™
 The cable length is around 30cm.



I. SAM21

HF sensor head
 Photocell Advance™
 IP65
 The cable length is around 65cm.



J. SAM22

HF sensor head
 Flush mount
 The cable length is around 65cm.



K. SAM23

HF sensor head
 Photocell advance™
 Daylight sensor
 For highbay application
 The cable length is around 30cm.



Optional Accessory: Reinforced Bluetooth Antenna

For some special applications, customers may need a larger Bluetooth transmission for both smartphone to device and device to device. Thanks to the reinforced Bluetooth antenna, with it being added to the control base HC038V/BT & HCDO38/BT, the transmission distance (smartphone to device) enlarges to 20m, the distance of device to device is around 50m.



Detection Pattern

SAM23



Ceiling mounted detection pattern (m)

SAM20 / SAM21 / SAM22



Ceiling mounted detection pattern (m)

HIRO5 / HIRO7



HIR11

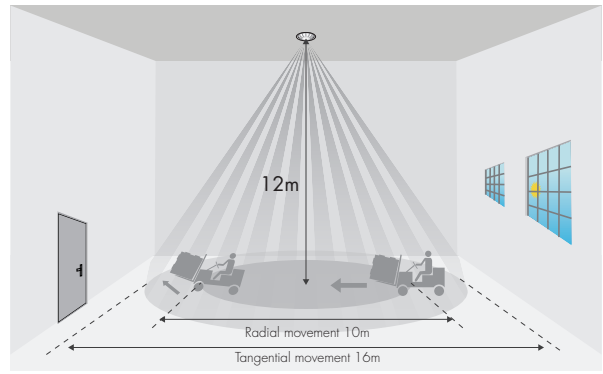

HIR12



Dimming Interface Operation Notes

Switch-Dim

The provided Switch-Dim interface allows for a simple dimming method using commercially available non-latching (momentary) wall switches. Detailed Push switch configurations can be set on Koolmesh app.

Switch Function	Action	Descriptions
Push switch	Short press (<1 second) * Short press has to be longer than 0.1s, or it will be invalid.	- Turn on/off - Turn on only - Turn off only - Recall a scene - Exit manual mode - Do nothing
	Double push	- Turn on only - Turn off only - Recall a scene - Exit manual mode - Do nothing
	Long press (≥1 second)	- Dimming - Colour tuning - Do nothing
Simulate sensor	/	- Upgrade a normal on/off motion sensor to a Bluetooth controlled motion sensor

Additional Information / Documents

1. For full explanation of Hytronik Photocell Advance™ technology, please kindly refer to [www.hytronik.com/download ->knowledge ->Introduction of Photocell Advance](http://www.hytronik.com/download->knowledge->Introduction%20of%20Photocell%20Advance)
2. To learn more about detailed product features/functions, please refer to [www.hytronik.com/download ->knowledge ->Introduction of App Scenes and Product Functions](http://www.hytronik.com/download->knowledge->Introduction%20of%20App%20Scenes%20and%20Product%20Functions)
3. Regarding precautions for Bluetooth product installation and operation, please kindly refer to [www.hytronik.com/download ->knowledge ->Bluetooth Products - Precautions for Product Installation and Operation](http://www.hytronik.com/download->knowledge->Bluetooth%20Products%20-%20Precautions%20for%20Product%20Installation%20and%20Operation)
4. Regarding precautions for microwave sensor installation and operation, please kindly refer to [www.hytronik.com/download ->knowledge ->Microwave Sensors - Precautions for Product Installation and Operation](http://www.hytronik.com/download->knowledge->Microwave%20Sensors%20-%20Precautions%20for%20Product%20Installation%20and%20Operation)
5. Regarding precautions for PIR Sensors installation and operation, please kindly refer to [www.hytronik.com/download ->knowledge ->PIR Sensors - Precautions for Product Installation and Operation](http://www.hytronik.com/download->knowledge->PIR%20Sensors%20-%20Precautions%20for%20Product%20Installation%20and%20Operation)
6. Data sheet is subject to change without notice. Please always refer to the most recent release on [www.hytronik.com/products/bluetooth technology ->Bluetooth Sensors](http://www.hytronik.com/products/bluetooth%20technology->Bluetooth%20Sensors)
7. Regarding Hytronik standard guarantee policy, please refer to [www.hytronik.com/download ->knowledge ->Hytronik Standard Guarantee Policy](http://www.hytronik.com/download->knowledge->Hytronik%20Standard%20Guarantee%20Policy)

HYTRONIK ELECTRONICS CO.,LTD
3rd Floor, block C, complex building, 155#, Bai'gang road south, Bai'gang village
Xiao Jin Kou town, Huicheng district
516023 Huizhou
China

INSTRUCTION **alevo**

AVAMP 6571



REGIOLUX

Regiolux GmbH
 Hellinger Str. 3
 D-97486 Königsherg/Bay.
 Telefon (0 95 25) 89-0
 Telefax (0 95 25) 89 73 4
<http://www.regiolux.de>
 e-Mail: info@regiolux.de



Achtung:
 Leuchte nicht öffnen!
 Garantieverlust!

Attention:
 Don't open the luminaire!
 Loss of guarantee!

Attention:
 Ne pas ouvrir le luminaire!
 Perte de garantie!

Atención:
 No abrir la luminaria!
 Pérdida de garantía!

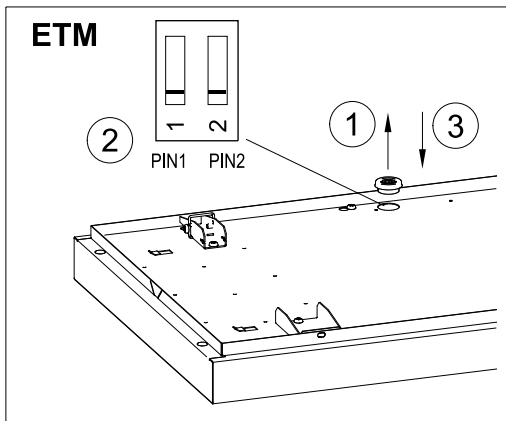

AVAMP/1500x355 7000-4200 840	
200 mA	~ 4200 lm / 28 W
250 mA	~ 5100 lm / 35 W
300 mA	~ 6100 lm / 43 W
350 mA	~ 7000 lm / 51 W

AVAMP/1500x355 6500-3900 830	
200 mA	~ 3900 lm / 28 W
250 mA	~ 4800 lm / 35 W
300 mA	~ 5600 lm / 43 W
350 mA	~ 6500 lm / 51 W

AVAMP/1500x240 4500-2700 840	
200 mA	~ 2700 lm / 19 W
250 mA	~ 3300 lm / 24 W
300 mA	~ 3900 lm / 29 W
350 mA	~ 4500 lm / 34 W

AVAMP/1500x240 4200-2500 830	
200 mA	~ 2500 lm / 19 W
250 mA	~ 3100 lm / 24 W
300 mA	~ 3600 lm / 29 W
350 mA	~ 4200 lm / 34 W



AVAMP/1200x355 5300-3100 840	
200 mA	~ 3100 lm / 21 W
250 mA	~ 3900 lm / 26 W
300 mA	~ 4600 lm / 32 W
350 mA	~ 5300 lm / 37 W

AVAMP/1200x355 4900-3000 830	
200 mA	~ 3000 lm / 21 W
250 mA	~ 3600 lm / 26 W
300 mA	~ 4300 lm / 32 W
350 mA	~ 4900 lm / 37 W

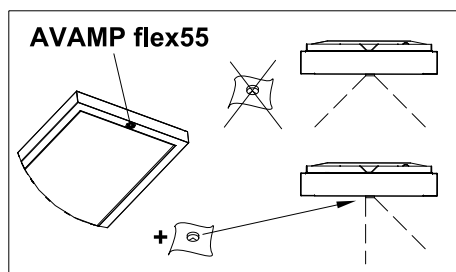

AVAMP/1200x240 3400-2000 840	
200 mA	~ 2000 lm / 14 W
250 mA	~ 2500 lm / 18 W
300 mA	~ 3000 lm / 21 W
350 mA	~ 3400 lm / 25 W

AVAMP/1200x240 3200-1900 830	
200 mA	~ 1900 lm / 14 W
250 mA	~ 2400 lm / 18 W
300 mA	~ 2800 lm / 21 W
350 mA	~ 3200 lm / 25 W

MONTAGE





LED



Sicherheitshinweise

(D)



Safety Information

(GB)



Consignes de sécurité

(F)



Allgemeine Sicherheitshinweise

- Montage, Inbetriebnahme und Wartung nur durch Elektrofachkraft.
- Arbeiten Sie nie bei anliegender Spannung an der Leuchte. Lebensgefahr durch Stromschlag!
- Elektrischer Anschluss muss ordnungsgemäß, entsprechend allen geltenden Normen und sonstigen nationalen und internationalen Sicherheits- und Unfallverhütungsvorschriften erfolgen.
- Beschädigte Leuchten dürfen nicht betrieben werden.
- Sicherheitshinweise und Montageanleitung beachten und aufbewahren
- Keine Haftung für Schäden durch unsachgemäßen Einsatz.
- Bei Instandsetzung nur Originalteile verwenden.
- Tragfähigkeit der Decke und Befestigungselemente sicherstellen.
- Leuchte ausschließlich für Innenraumeinsatz und Umgebungstemperaturen bis 25°C geeignet, sofern mittels Etikettierung der Leuchte nicht anders beschrieben.



Betrieb der Leuchte

- Ungewöhnliche Dunkelstellen können auf Teilausfall von LED hinweisen. Regelmäßig prüfen und betroffene Leuchten austauschen. Die Lichtquelle (LED) dieser Leuchte darf nicht durch den Anwender ausgetauscht oder ersetzt werden.
- Eine Überschreitung der zulässigen Umgebungstemperatur reduziert die Lebensdauer der Leuchte, im Extremfall droht Frühausfall.
- Die Betauung der Leuchte ist zu vermeiden.
- Jegliche mechanische Belastung der LED Platinen ist unzulässig.
- LED können durch elektrostatische Entladung (ESD) geschädigt werden, bis hin zum Totalausfall. Direkte Berührung ist stets zu vermeiden.
- In Abhängigkeit von deren Konzentration können Chemikalien die LED-Module angreifen und zu Lichtstromreduktion, Drift der Lichtfarbe bzw. Totalausfall führen. Direkter Kontakt mit Säuren, Laugen, Lösemitteln, flüchtigen organischen Verbindungen bzw. Ölen ist stets zu vermeiden. Um Schäden durch Ausgasungen zu vermeiden, ist eine ausreichende Be- und Entlüftung zu gewährleisten.
- Zur Vermeidung von EMV-Problemen Durchgangsverdrahtung nicht unmittelbar entlang der Leuchtenverdrahtung führen.
- Steuereingänge von dimmbaren Leuchten mit handelsüblichen für Netzspannung geeigneten Leitungen anschließen.



Änderungen unserer Produkte

Veränderung, Umarbeitung, Umkenzeichnung von Produkten können deren technische Eigenschaften negativ beeinflussen, diese zerstören und möglicherweise Folgeschäden an anderen Objekten verursachen. Für durch derartige Änderungen verursachte Schäden kann der Hersteller nicht verantwortlich gemacht werden.

- ▽ + IP5x - nicht leitfähiger Staub
- ▽ + IP6x - leitfähiger und nicht leitfähiger Staub



General Safety Information

- Installation, commissioning and maintenance only by qualified electrician.
- Never perform any work on the luminaire with voltage applied. Danger to life due to electric shock!
- Electric connection must be appropriate according to all applicable standards and other national and international safety and accident prevention regulations.
- Damaged luminaires must not be operated.
- Observe and retain safety instructions and mounting instructions
- No liability is accepted for damages resulting from improper use.
- Use genuine parts only for repair.
- Ensure stability of the ceiling and fastening elements.
- The luminaire is exclusively intended for interior rooms and ambient temperatures not exceeding 25°C, unless otherwise described by labeling the luminaire.



Operation of the luminaire

- Abnormal dark spots may be an indication of partial failure of LEDs. Inspect regularly and replace the luminaires affected. The light source (LED) of this luminaire must not be exchanged or replaced by the user.
- Exceeding the permissible ambient temperature will reduce the luminaire's lifecycle, resulting in premature failure in extreme cases.
- Avoid condensation of the luminaire.
- Any mechanical load to the LED circuit boards is not permitted.
- LEDs can be damaged by electrostatic discharge (ESD). This may result in total failure. Always avoid direct contact.
- Depending on their concentration, chemicals can corrode the LED modules and lead to reduction of luminous flux, drift of luminous colour and/or total failure. Always avoid direct contact with acids, bases, solvents, volatile organic compounds and/or oils. Ensure sufficient ventilation to prevent damage by gas release.
- Avoid ESD problems by not routing feed-through wiring directly along the wiring of the luminaire.
- Connect control inputs of dimmable luminaires with standard cables suitable for power supply voltage.



Changes to our products

Modification, reworking, re-marking of products can have a negative impact on their technical properties, destroy them and possibly cause consequential damage to other objects. The manufacturer cannot be held responsible for damage caused by such changes.

- ▽ + IP5x - dust nonconductive
- ▽ + IP6x - dust conductive and dust nonconductive



Consignes générales de sécurité

- Montage, mise en service et maintenance uniquement par un électricien spécialisé.
- Ne travaillez jamais sur un luminaire sous tension. Danger de mort par choc électrique !
- Le branchement électrique doit être réalisé de manière correcte et conforme à toutes les normes en vigueur et autres prescriptions nationales et internationales relatives à la sécurité et à la prévention des accidents.
- Ne pas faire fonctionner de luminaires défectueux.
- Respecter et conserver les consignes de sécurité et les instructions de montage
- Nous déclinons toute responsabilité en cas de dommages dus à une utilisation incorrecte.
- Utiliser uniquement des pièces d'origine pour la réparation.
- Veiller à ce que la capacité portante du plafond et des éléments de fixation soit suffisante.
- Sauf indication contraire indiquée sur l'étiquette du luminaire, luminaire conçu uniquement pour une utilisation en intérieur et une température ambiante maximale de 25 °C.



Fonctionnement du luminaire

- Des zones d'ombre inhabituelles peuvent indiquer un défaut partiel des LED. Contrôler régulièrement et remplacer les luminaires concernés. Utilisateur n'est pas autorisé à échanger ou à remplacer la source de lumière (LED) de ce luminaire.
- Le dépassement des températures ambiantes admissibles réduit la longévité du luminaire; dans les cas extrêmes, cela peut entraîner des pannes prématurées.
- Éviter toute condensation sur le luminaire.
- Ne jamais soumettre les platines à LED à des charges mécaniques.
- Les décharges électrostatiques (DES) peuvent endommager les LED et entraîner leur destruction totale. Toujours éviter le contact direct.
- En fonction de leur concentration, les produits chimiques peuvent attaquer les modules à LED et entraîner une baisse du flux lumineux, une dérive de la température de couleur voire une panne totale. Toujours éviter le contact direct avec les acides, les lessives alcalines, les solvants, les composés et huiles organiques volatils. Assurer une ventilation et une aération suffisantes pour éviter les dégâts dus aux dégagements de gaz.
- Pour éviter les problèmes de CEM, ne pas poser le câblage de liaison directement à côté du câblage du luminaire.
- Brancher les entrées de commande des luminaires à gradation à l'aide de câbles standard adaptés à la tension secteur.



Modification de nos produits

La modification, la transformation et la modification de marquage des produits peuvent avoir une influence négative sur leurs propriétés techniques, détériorer les produits et causer des dommages indirects sur d'autres objets. Le fabricant ne saurait être tenu responsable des dommages causés par ces modifications.

- ▽ + IP5x - non conductrice de la poussière
- ▽ + IP6x - poussière conductrice et de la poussière non conductrice

Information für Wartung, Reinigung und Entsorgung von LED-Leuchten Information for service, cleaning and disposal of luminaire

Instruktion für Wartung von Leuchten: Instruction for luminaire service:

Ersetzen von alten oder ausgefallenen LED Replace aged or failed LED 	Instruktion für Ende der Lebensdauer: Instruction for end of life :	Ausschalten, Stromzufuhr zur Leuchte unterbrechen Switch off, switch off supply to luminaire 	Batterie entfernen zur Entsorgung Remove battery for disposal 	Leuchte entfernen zur Entsorgung Remove luminaire for disposal 	Das Material an WEEE Entsorgungsstelle liefern Dispatch materials to WEEE recycling plant
---	--	---	--	---	--

Instruktion für Reinigung von Leuchten: Instruction for luminaire cleaning

Leuchte reinigen Clean luminaire 	Ausschalten, Stromzufuhr zur Leuchte unterbrechen Switch off, switch off supply to luminaire 	Leuchte außen reinigen Clean outside luminaire 	Nur bei SELV! Only SELV!			Funktionstest durchführen Make functional test
	Optik entfernen Remove optic 	Leuchte innen reinigen Clean inside luminaire 	Optik wieder anbringen Refit optic 			

**Advertencias de seguridad**

E

**Avvertenze sulla sicurezza**

I

**Zasady bezpieczeństwa**

PL

**Advertencias de seguridad generales**

- El montaje, la puesta en funcionamiento y el mantenimiento deberán ser realizados exclusivamente por electricistas profesionales.
- No realice nunca trabajos en la luminaria cuando esta esté sometida a tensión. ¡Peligro de muerte por descarga eléctrica!
- La conexión eléctrica se debe realizar de modo reglamentario, de conformidad con todas las normas vigentes y con las demás prescripciones nacionales e internacionales de seguridad y prevención de accidentes.
- Tenga en cuenta las advertencias de seguridad y las instrucciones de montaje y conserve los documentos correspondientes como referencia.
- No se asume ninguna responsabilidad por daños debidos a un uso antirreglamentario.
- Al hacer reparaciones, utilice exclusivamente piezas originales.
- Asegúrese de que el techo y los elementos de fijación tengan la capacidad de carga suficiente.
- A menos que se describa lo contrario etiquetando la luminaria, la luminaria es apta exclusivamente para su uso en interiores y a una temperatura ambiente de hasta 25 °C.

**Funcionamiento de la luminaria**

- La aparición de puntos oscuros inusuales puede ser indicio de la avería de algunos ledes. Realice revisiones periódicas y sustituya las luminarias defectuosas.
- El rebase de la temperatura ambiente permitida conlleva una reducción de la vida útil de la luminaria y, en casos extremos, el riesgo de una avería prematura.
- Se debe evitar la condensación en la luminaria.
- Está prohibida toda carga mecánica sobre las pletinas de los ledes.
- Una descarga electrostática podría provocar daños en los ledes e incluso una avería total. Se deberá evitar siempre el contacto directo con estos.
- Según su grado de concentración, los productos químicos pueden atacar los módulos de ledes y provocar una reducción del flujo luminoso, alteraciones en el tono de la luz o una avería total. Se debe evitar bajo cualquier circunstancia el contacto directo con ácidos, lejías, disolventes, compuestos orgánicos volátiles o aceites. Para evitar daños debidos a las emisiones de gas, es necesario garantizar una ventilación suficiente de entrada y salida.
- Para evitar problemas de compatibilidad electromagnética, no tienda los cables de paso junto a los cables de la luminaria.
- Conecte las entradas de mando de luminarias atenuables mediante cables convencionales adecuados para tensión de red.

Modificaciones de nuestros productos

La modificación, la reelaboración y el remarcado de los productos pueden influir negativamente en sus propiedades técnicas, destruirlos y, posiblemente, causar los consiguientes daños a otros objetos. El fabricante no se hace responsable de los daños causados por dichas modificaciones.

▽+ IP5x - polvo no conductor

▽+ IP6x - polvo conductor y no conductor

**Avvertenze generali sulla sicurezza**

- Il montaggio, l'impiego e la manutenzione devono essere eseguiti solo da un elettricista specializzato.
- Non lavorare mai sulla lampada con tensione elettrica inserita. Pericolo di morte a causa di scossa elettrica!
- L'allacciamento elettrico deve essere eseguito a regola d'arte, in conformità a tutte le norme vigenti, alle disposizioni nazionali e internazionali di sicurezza e alle normative antinfortunistiche.
- Le lampade danneggiate non devono essere utilizzate ulteriormente.
- Osservare e conservare le avvertenze di sicurezza e le istruzioni di montaggio.
- Non lavorare mai sulla lampada con tensione elettrica inserita.
- Per le riparazioni utilizzare solo parti di ricambio originali.
- Verificare la portata del soffitto e degli elementi di fissaggio.
- La lampada è prevista solo per uso interno e temperature ambiente fino a 25 °C, se non diversamente descritto dall'etichettatura dell'apparecchio.

**Funzionamento della lampada**

- Punti scuri insoliti possono indicare un guasto parziale dei LED. Controllare regolarmente e sostituire le lampade in questione.
- Il superamento della temperatura ambiente consentita riduce la durata utile della lampada, in casi estremi si rischia un guasto precoce.
- Evitare la condensazione della lampada.
- È vietata qualsiasi sollecitazione meccanica delle schede LED.
- I LED possono essere danneggiati dalle scariche elettrostatiche (ESD), con possibilità di guasto totale. Si deve sempre evitare il contatto diretto.
- In rapporto alla loro concentrazione, le sostanze chimiche possono aggredire i moduli LED provocando la riduzione del flusso luminoso, la deriva del colore della luce o un guasto totale. Si deve sempre evitare il contatto diretto con acidi, basi, solventi, composti organici volatili o oli. Per evitare danni da emissioni di gas, si deve garantire una sufficiente ventilazione e disaerazione.
- Per evitare problemi di CEM, il cablaggio di transito non deve essere posato direttamente insieme al cablaggio della lampada.
- Collegare gli ingressi di comando delle lampade dimmerabili (varialuce) usando dei cavi adeguati per la tensione di rete.

Modificaciones de nuestros productos

Modifiche, conversioni, cambi dell'etichettatura apportati ai prodotti possono influenzare negativamente le loro proprietà tecniche, distruggerli ed eventualmente causare danni ad altri oggetti. Il produttore non può essere ritenuto responsabile di eventuali danni causati da tali modifiche.

▽+ IP5x - polvere non conduttiva

▽+ IP6x - polvere conduttiva e non conduttiva

**Ogólne zasady bezpieczeństwa**

- Prace związane z montażem, uruchomieniem i konserwacją może wykonywać tylko elektryk.
- Nigdy nie wykonywać prac przy oprawie, gdy znajduje się ona pod napięciem. Niebezpieczeństwo dla życia z powodu porażenia prądem!
- Przyłącze elektryczne musi być wykonane profesjonalnie, zgodnie ze wszystkimi obowiązującymi normami oraz innymi krajowymi i międzynarodowymi przepisami bezpieczeństwa i zapobiegania wypadkom.
- Przestrzegać zasad bezpieczeństwa i wytycznych instrukcji montażu oraz zachować je do późniejszego użytku.
- Producent nie ponosi odpowiedzialności za nieprawidłowe stosowanie.
- W przypadku naprawy używać tylko oryginalnych części.
- Zapewnić nośność sufitu i elementów mocujących.
- Oprawa przeznaczona jest wyłącznie do stosowania w pomieszczeniach w temperaturach otoczenia do 25 °C, o ile nie opisano inaczej, oznaczając oprawę.

**Eksplotacja oprawy**

- Nietypowe zaciemnione miejsca mogą wskazywać na częściową awarię oprawy LED. Należy regularnie dokonywać kontroli i wymieniać uszkodzone oprawy.
- Przekroczenie dopuszczalnej temperatury otoczenia skracza trwałość oprawy, w skrajnym przypadku grozi przedwczesną awarią.
- Unikać obciążenia oprawy.
- Niedopuszczalne jest jakiegokolwiek obciążenie mechaniczne płytek LED.
- Diody LED mogą ulec uszkodzeniu wskutek wyładowania elektrostatycznego (ESD), a nawet ulec całkowitej awarii. Zawsze należy unikać bezpośredniego kontaktu.
- W zależności od stężenia chemikalia mogą uszkodzić moduły LED i prowadzić do obniżenia strumienia światła, zmiany barwy światła lub całkowitej awarii. Zawsze należy unikać bezpośredniego kontaktu z kwasami, ługami, rozpuszczalnikami, lotnymi związkami organicznymi lub olejami. Celem uniknięcia szkód z powodu emisji gazów należy zapewnić odpowiednią wentylację i odpowietrzanie.
- Aby uniknąć problemów EMC, nie prowadzić okablowania przelotowego bezpośrednio wzdłuż okablowania oprawy.
- Wejścia sterujące opraw z funkcją ściemniania podłączać za pomocą dostępnych powszechnie w sprzedaży przewodów odpowiednich od napięcia sieciowego.

Zmiany naszych produktów

Zmiany, przeróbki, modyfikacja oznaczeń produktów mogą mieć negatywny wpływ na ich parametry techniczne, spowodować ich awarię, a także być możliwą przyczyną powstania szkód następczych w innych obiektach. Producent nie odpowiada za szkody spowodowane tego typu modyfikacjami.

▽+ IP5x - pył nieprzewodzący

▽+ IP6x - pył przewodzący i nieprzewodzący

BG



Инструкциите за безопасност на вашия национален език можете да намерите Интернет.

DK



Sikkerhedsinstruktionerne på dit lands sprog findes på Internettet.

EST



Riikliku keele ohutusjuhiseid leiab Internetist.

HR



Sigurnosne upute na vašem nacionalnom jeziku mogu se naći na Internetu.

LV



Drošības norādījumus savā valsts valodā var atrast internetā.

LT



Saugos nurodymus savo valstybine kalba galima rasti internete.

N



Sikkerhetsinstruksjonene på ditt nasjonalspråk finnes på Internett.

P



As instruções de segurança em sua língua nacional podem ser encontradas na Internet.

RO



Instrucțiunile de siguranță din limba dvs. națională pot fi găsite pe Internet.

S



Säkerhetsanvisningarna på ditt nationella språk finns på Internet.

SK



Bezpečnostné pokyny vo vašom národnom jazyku nájdete na internetovej.

SLO



Varnostna navodila v vašem nacionalnem jeziku so na voljo na spletni strani.

CZ



Bezpečnostní pokyny ve vašem národním jazyce naleznete na internetu.

TR



Ulusal dilinizdeki güvenlik talimatları internette.

H



A nemzeti nyelvű biztonsági utasítások megtalálhatók az interneten.

CY



Οι οδηγίες ασφάλειας στην εθνική σας γλώσσα διατίθενται στο διαδίκτυο.

GR

